

Instruction manual



THS 4004
4 x 100W RMS
CLASS D



The installation of this product must be made by a qualified professional.

Index

- 01** • Introduction
 - Presentation
- 02** • Important recommendations
 - Audio source
 - Package content
- 03** • Knowing your equipment
 - Front panel
- 04** • Front panel (sequence)
- 05** • Function configuration mode
 - Knowing your equipment
 - Rear panel
- 06** • Protection system
 - Remote control function
- 07** • Bluetooth
 - Bluetooth use example
- 08** • Example of using Optical input
 - Example of using RCA input (AUX 2)
 - Connect control use example
- 09** • Examples of connections
 - Term of warranty
 - Technical assistance
- 10** • Technical features

Introduction

Congratulations on purchasing a Taramps product.

Developed in a modern laboratory, with highest technology and highly qualified professionals.

This manual explains all the resources, operations and guidelines for resolving questions that may arise in your installation. Take a time to read it carefully and ensure the proper installation and use of all the benefits that this product can offer.

In case of doubt even after reading this manual, please contact our technical support at the number **+55 18 3266 4050** or our website **www.taramps.com.br**.

Presentation

The TARAMPS THS 4004 is a Receiver developed with high technology to integrate different environments. Compact and powerful it can be used in several applications providing quality sound.

Application examples:

- Environment sound for stores, shops and clinics. It also allows, through the microphone input, that warnings are transmitted via the sound system.
- In your leisure area, gourmet space, country house, etc. Including various audio input options, such as Bluetooth, Micro SD, AUX and USB, it allows the audio sources to be easily changed giving the user flexibility in choosing the preferred audio.

The equipment is automatic bivolt and can be connected to any power plug between 90 and 240V. It has a switching power supply that is more efficient in the consumption of electricity. To turn the device on and off, use the ON/OFF switch located on the front panel. Keep turned off when not in use.

If you are not going to use the product for a long time, we recommend that you disconnect from the power plug.

Important recommendations

- The THS 4004 must be installed in a firm and ventilated place, away from heat and humidity places. Avoid locations with direct sunlight.
- Do not block the ventilation holes on the top and rear.
- Avoid falls and impacts.
- Carefully observe the polarity and impedance of the loudspeakers.
- Use cables according to the distance between the THS 4004 and the loudspeakers.

The table below shows the recommended gauges according to the distances:

Until 20m (65,6 ft)	cables with a gauge larger than or equal to	1 mm² (17 AWG)
Until 40m (131,2 ft)	cables with a gauge larger than or equal to	1,5 mm² (15 AWG)
Until 70m (229,6 ft)	cables with a gauge larger than or equal to	2,5 mm² (13 AWG)
Until 100m (328 ft)	cables with a gauge larger than or equal to	4 mm² (11 AWG)

- In case of unwanted noise make sure that the cables and connections are in good condition.

Audio source

The TARAMPS THS 4004 has the following audio inputs:

1. USB: Flash drive input *
2. MICRO SD CARD *
3. AUX (front): P2 standard auxiliary input
4. AUX1 and AUX2: RCA standard auxiliary inputs
5. BLUETOOTH
6. FM radio
7. Microphone input (standard P10)
8. Optical Input

* The connected device must contain music in MP3 format to be identified by the equipment. Maximum supported size: 64GB.

 We advise you to always have a good antivirus, so there are no problems with the Flash Drive or micro SD card when connecting to the product. Infected devices may cause undesirable effects to the THS 4004, such as: Slow music reading and general failures.

Do not use the USB input to connect to the computer or to recharge other devices that have batteries.

Package content

- 01 Multi Channel Receiver THS 4004



- 01 Remote Control



- 01 Optical Cable



Illustrative image

- 01 Bluetooth Antenna

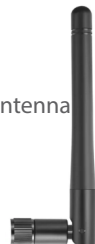

Knowing your equipment

Front Panel

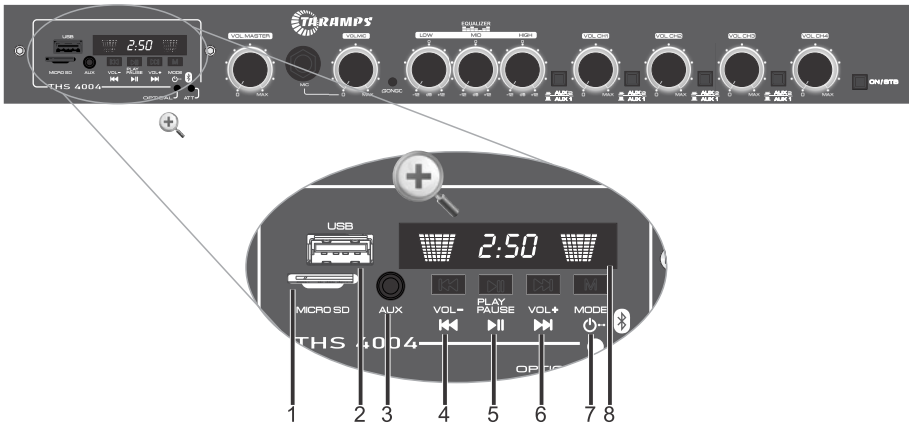

1 - MICRO SD: Micro SD memory card input. 
(The card must be positioned as the image shows, with the terminals facing up).

2 - USB: Flash Drive input.

3 - Aux. (P2 Connector): Receives audio signal from the P2 output of your phone, tablet, MP3, computer, among others. Use good quality cable to avoid unwanted noise.

4 - Track - /Volume -:

Short Touch: Rewind the music tracks in the USB/SD/BLUETOOTH. Reduce 0.1MHz of the frequency.

Long Touch: Reduce the volume in all sources options. Automatic search to previous stations.

5 - Play /Pause:

Short Touch: Pause or start the music on USB / SD / BLUETOOTH. Advances next saved memory position of FM stations.

Mute for AUXILIARY option.

Long Touch: Searches for FM stations and saves them in memory.

6 - Track + /Volume +:

Short Touch: Forward the music tracks in the USB/SD/ BLUETOOTH. Increase 0.1MHz of the frequency.

Long Touch: Increase the volume in all sources options. Automatic search to next stations.

7 - Mode / ON/OFF:

Short Touch: Changes the source options, such as: USB / SD / AUXILIARY / BLUETOOTH / FM.

Long Touch: Turns the player on or off, leaving only the microphone input active.

8 - LED Display - Remote control IR sensor: For better communication between the remote control and the device, point the control at this point on the display.

Front Panel (sequence)

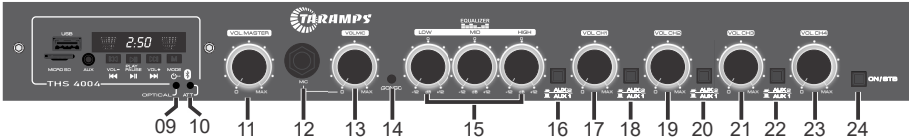

9 - OPTICAL: LED indicating the presence of an optical signal. Indicates that the current auxiliary input is optical.

10 - ATT: LED audio attenuation indicator.

When identifying an audio signal from the microphone input or emitting the ding-dong signal (GONGO), the equipment attenuates the output signal, allowing higher evidence of the microphone. After 2 seconds without using the microphone, it returns to the state without attenuation.

It is possible to enable or disable this function. See page 05 (Function configuration mode).

11 - MASTER: Controls the overall volume of the Bluetooth, USB, Micro SD, FM, AUX, AUX1, OPTICAL and AUX2 inputs.

12 - MIC: P10(1/4") input for microphone.

Microphone Recommendations:

- The microphone signal has a low amplitude, so improper use can cause unwanted noise.
- Use quality cables and connectors.
- Do not wrap the microphone cables.
- Do not pass the microphone in front of the loudspeakers. This causes microphone feedback.

13 - VOL. MIC: Adjusting the volume of the microphone and the GONGO (ding-dong). If you do not use the microphone and GONGO, it is recommended to keep the volume to a minimum.

14 - GONGO: GONGO activation key.

The product has 2 GONGO options. To select another option with the device on, touch and hold the "GONGO" key. The 2 gong patterns will be emitted in sequence (do not release the key). To select an option, release the "GONGO" key after hearing the desired option.

15 - EQUALIZATION: 3 band equalizer control.

LOW: Bass frequencies

MID: Middle frequencies

HIGH: High frequencies

16 - 18 - 20 - 22 - AUX1 / OPTICAL or AUX 2 KEY: Button pressed: Selects AUX2, Optica inputs. Button not pressed: Selects AUX input 1. (Inputs on rear panel).

17 - VOL CH1: Adjusts the volume of channel 1.

19 - VOL CH2: Adjusts the volume of channel 2.

21 - VOL CH3: Adjusts the volume of channel 3.

23 - VOL CH4: Adjusts the volume of channel 4.

18 - TECLA ON/STB: Turn ON the receiver or stay in standby mode.

On, indicates that the product is plugged into the outlet in stand by mode.

Function configuration mode

With the device in Standby, touch and hold the **ON/STB key (14)** for more than 5 seconds. The blue LEDs on the panel will indicate the current status, being:

-**OPTICAL(9)** lit, indicates that the AUTO TURN ON function is active. To change the status of this function, touch the **ON/STB button (14)** repeatedly until the LED goes out.

-**ATT(10)** lit, indicates that the attenuation function is active. To change the status of this function, touch the **GONGO key (14)**.

To exit programming, touch and hold the **ON/STB key (24)** for more than 5 seconds.

Knowing your equipment

Rear Panel

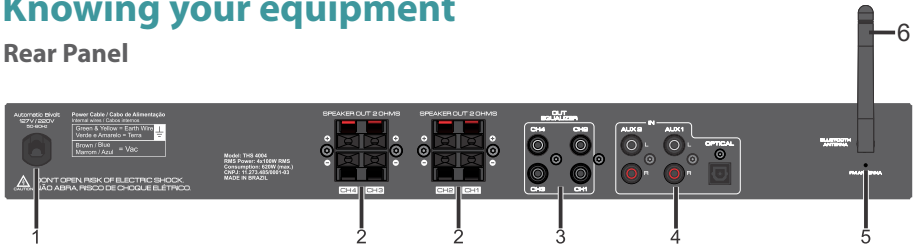

1 - POWER CABLE: Plugged it into a powered outlet. This product operates from 127V AC to 220V AC.

2 - SPEAKER OUT: Power outputs for connecting speakers. The THS 4004 has 4 individual power outputs. Follow the indicated polarity and the recommended minimum impedance of 2 Ohms.

3 - OUT EQUALIZER: The OUT EQUALIZER output allows sending the audio signal (1V RMS - maximum) to other equipment, such as another THS 4004, an amplifier or active subwoofer. This signal goes through the equipment's equalization settings (LOW, MID and HIGH) and volume. The audio of each output corresponds to the selection of inputs made individually on each channel.

4 - INPUT AUX 1, OPTICAL e AUX 2: Audio inputs. To use these inputs, the device must be in the AUX or DIRECT AUX function. Use the AUX1/AUX2 front button to select the desired input. OPTICAL input is automatically selected when an optical signal is present, regardless of the position of the front panel AUX1/AUX2 key. Using the OPTICA input, you have the AUTO TURN ON/OFF system, which automatically turns the device on/off when there is an optical signal at the input. This function can be disabled according to the configuration instructions at the top of this page.

IMPORTANT: For the optical signal to work correctly, the TV or signal source must be configured as standard PCM output. Strong noises indicate that the received signal is not PCM standard. In this case, check the TV menu to see if the digital audio output format is PCM. (Consult your TV manufacturer's manual).

6 - FM ANTENNA: Indoor wire antenna for FM radio reception. Position the wire antenna in order to achieve the best FM reception.

7 - BLUETOOTH ANTENNA: External antenna for better reception of the Bluetooth range.

Protection system

The THS 4004 has a protection system against outputs overload and outputs short circuit. When the protections are activated, the ATT LED on the front panel turns on temporarily and the audio output is interrupted. About 2 seconds, or the audio is restored. If the protection system or system meets frequently, review the settings and installation of your system.

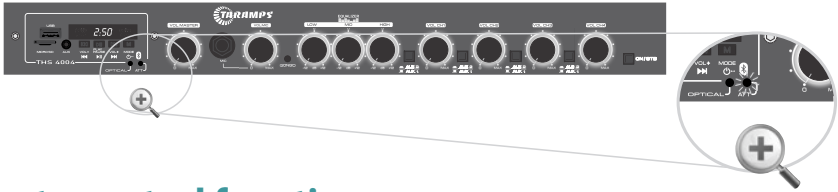

Remote control functions

The THS 4004 has a compact remote control, so you can remotely control the device with practicality.



-  **ON / OFF:** Press this key to turn the player on or off.
-  **MODE:** Switch the audio source (USB, BLUETOOTH, SD, AUXILIARY, FM).
-  **MUTE:** Player only.
-  **PLAY / PAUSE:** Pause or start the music to USB / SD / BLUETOOTH.
FM: Short Press: Advances next saved memory location of FM stations.
Long Press: Searches for FM stations and saves them in memory.
-  **TRACK- / FOLDER- / FM-:**
TRACK- Rewinds the music track (short press)
FOLDER- Goes back to the folder (long press)
FM: Short press: Decreases the frequency by 0.1 MHz.
Long press: Automatically searches for the previous station.
-  **TRACK+ / FOLDER+ / FM+:**
TRACK+ Advances the music track (short press)
FOLDER+ Advance the folder (long press)
FM: Short press: Increases the frequency by 0.1 MHz.
Short long: Automatically searches for the next station.
-  **EQUALIZATION:** Pop / Rock / Jazz / Country / Normal.
Do not work in auxiliary mode.
FM: Short Press Return to the saved memory position of FM stations.
-  **VOL-:** Volume down
-  **VOL+:** Volume up
-  **REPEAT:** Repeat /play MP3 options
- NUMERIC KEYBOARD:** FM: Long Press saves FM stations.

NOTE: The SCN, REC and STOP keys have no function.

Bluetooth

When selecting the Bluetooth function (identified with "bt" on the display), the THS 4004 waits for a Bluetooth connection. Search for the device called "TARAMPS" using your phone, tablet, PC or other and match it.

-To connect to a new device, disconnect the current one and make the new Bluetooth pairing. Bluetooth specification: class II with a 50 m (164 ft) maximum range and may vary according to the environment (such as walls) and the connected device.



For other devices the connection system is similar (consult manufacturer's manual)

Bluetooth use example

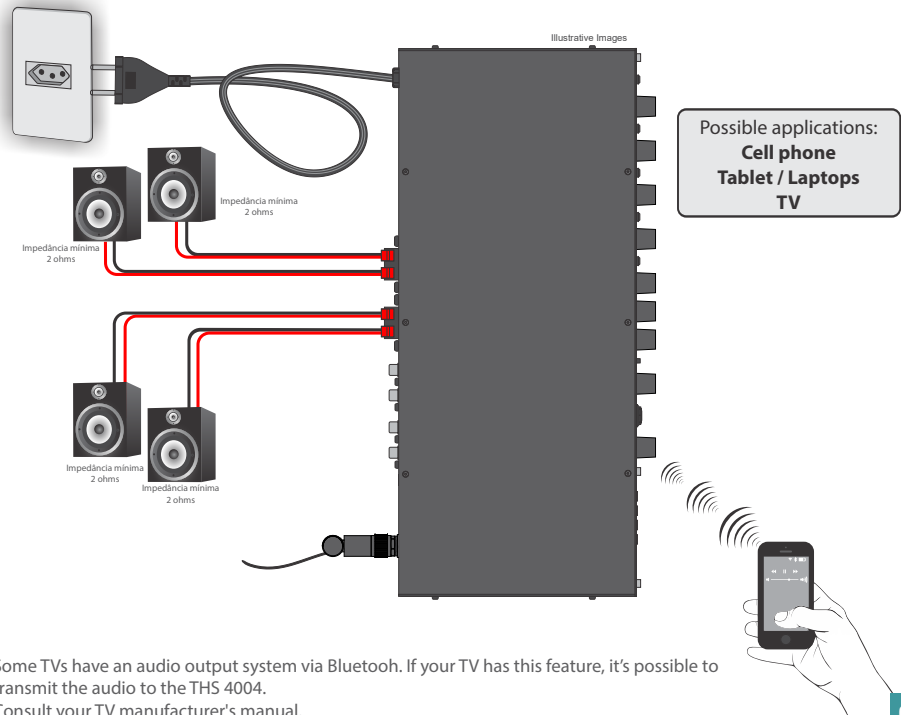

Some TVs have an audio output system via Bluetooth. If your TV has this feature, it's possible to transmit the audio to the THS 4004. Consult your TV manufacturer's manual.

Technical features

TARAMPS THS 4004:	Receiver Multi Channel Classe D
Number of channels:	04
RMS Power:	400W (4 x 100W) ABNT NBR IEC 60268-3*
Nominal RMS power of each channel:	100W / 200W BRIDGED
Rated RMS output voltage of each channel:	14.2Vrms / 28.4Vrms Bridged
Total Harmonic Distortion + Noise (THD + N) at the nominal power of each channel (100W)	<10%
Nominal impedance of each channel	2 Ohms / 4 Ohms Bridged
MIC Sensitivity:	10 mV
AUX input sensitivity:	200 mV
MIC input impedance:	2.2K Ohms
AUX input impedance:	5K Ohms
Frequency response (equalizers at 0dB):	10Hz ~ 50KHz (-3db) - 4 OHMS
Typical performance of the 3-way equalizer:	
Low:	±12dB - 80Hz
Mid:	±12dB - 2KHz
High (treble):	±12dB - 12KHz
Power supply:	90 ~ 140VAC or 190 ~ 240VAC
Maximum consumption:	600W
Stand by consumption:	6W
Internal protection fuse:	6A
Protection System:	Thermal protection, Output protection against short-circuit and low impedance**
Signal to noise ratio:	>90db
FM frequency range:	87.5 MHz ~ 108MHz
Dimensions (W x H x D):	452 x 60 x 186mm (17.80" x 2.36" x 7.32")
Weight:	2,16K (4.75lb)

*Nominal power with 1KHz sinusoidal signal and 2 Ohms resistive load. (Measured in accordance with ABNT NBR IEC 60268-3 Sound equipment, Part 3: Amplifiers).

**See protection system on page 06.

The values mentioned are typical and may change due to the tolerance of components or the manufacturing process. For more information or questions visit our website or contact TARAMPS support.



Taramps reserves the right to modify the contents of this manual without prior notice and not to apply the modifications to units previously produced.



+55 18 3266-4050

Manufactured by:
TARAMPS ELECTRONICS LTDA
TAX ID: 11.273.485/0001-03
Rodovia/Highway: Julio Budisk, SN, KM 30
Alfredo Marcondes - SP
Made in Brazil
www.taramps.com.br